

Montážny návod

*Knižnica
s predelom*

Rev. 22.10.2024

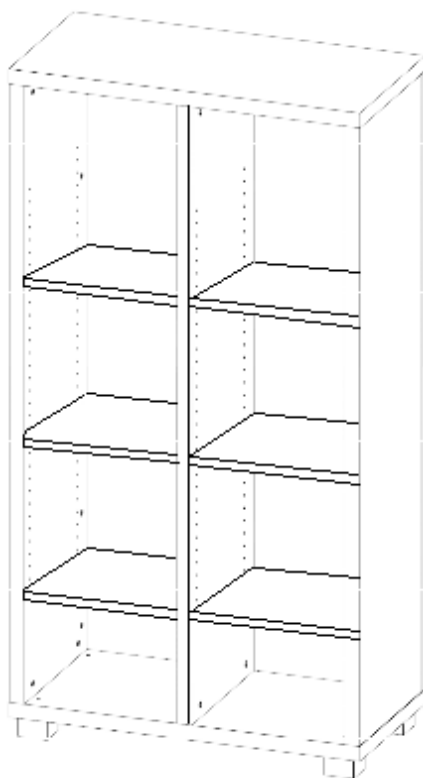

Zoznam dielov a komponentov

p. č.	Názov dielu	ks
1	Zadna stena	1
2	Ľavý bok	1
3	Pravý bok	1
4	Horná doska	1
5	Spodná doska	1
6	Stred	1

p. č.	Názov dielu	ks
7	Excenter 15x19mm	6
8	Excenter 15x29mm	24
9	Tiahlo excentra - malé	30
10	Kolík 8x35	72
11	Noha	4
12	Skrutka 4x30	16

Výška knižnice	Police	Podperky
1700 mm	6x	24x
2100 mm	8x	32x
2450 mm	12x	48x

Náradie potrebné na montáž

V balení:

Ďalšie potrebné náradie:

- krížový skrutkovač
- plochý skrutkovač
- kovové kladivo
- gumenné kladivo

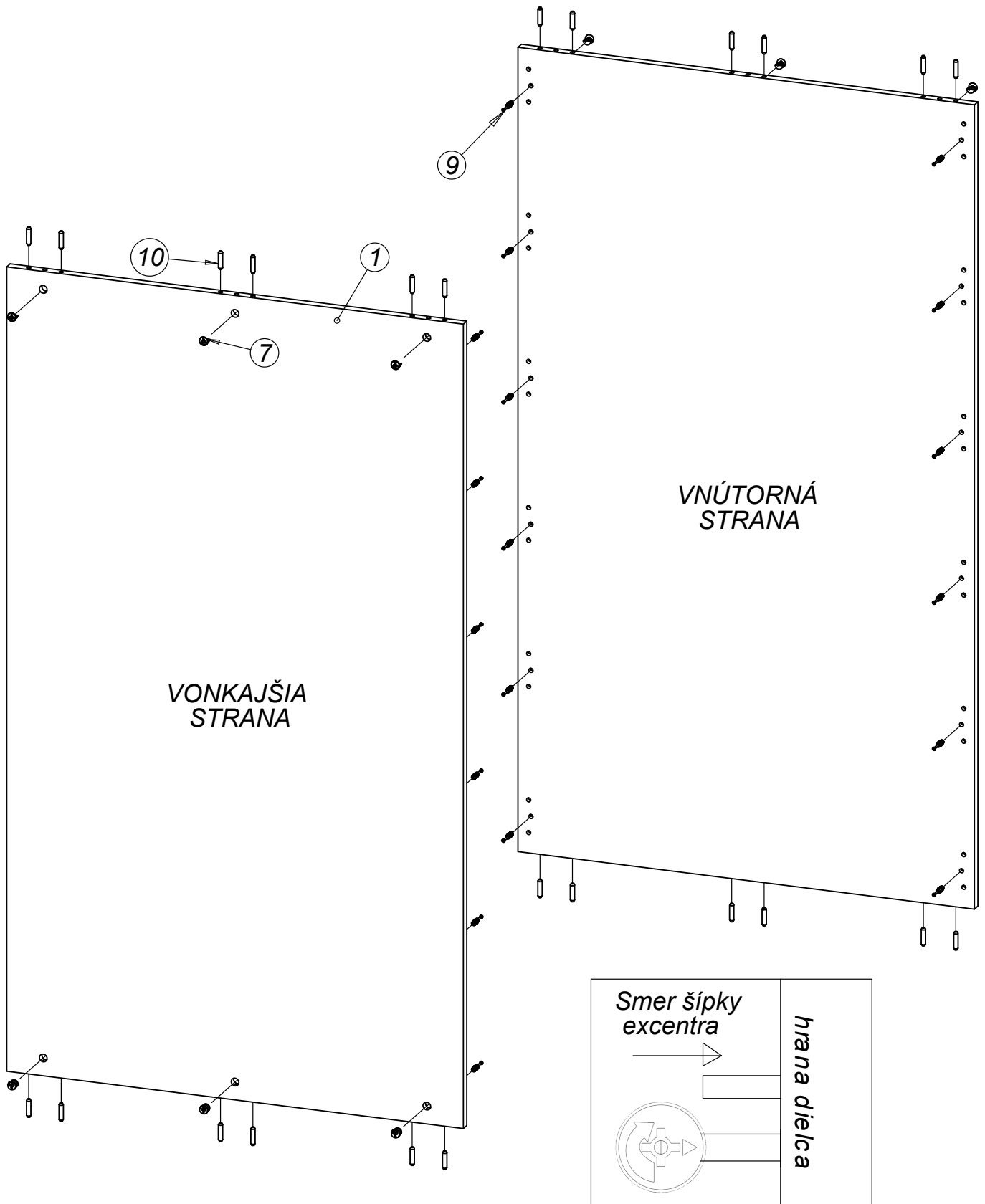
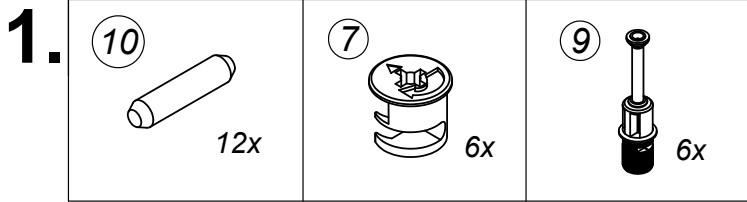

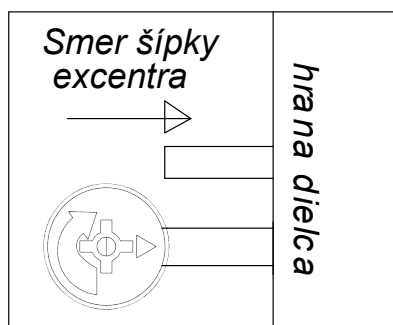
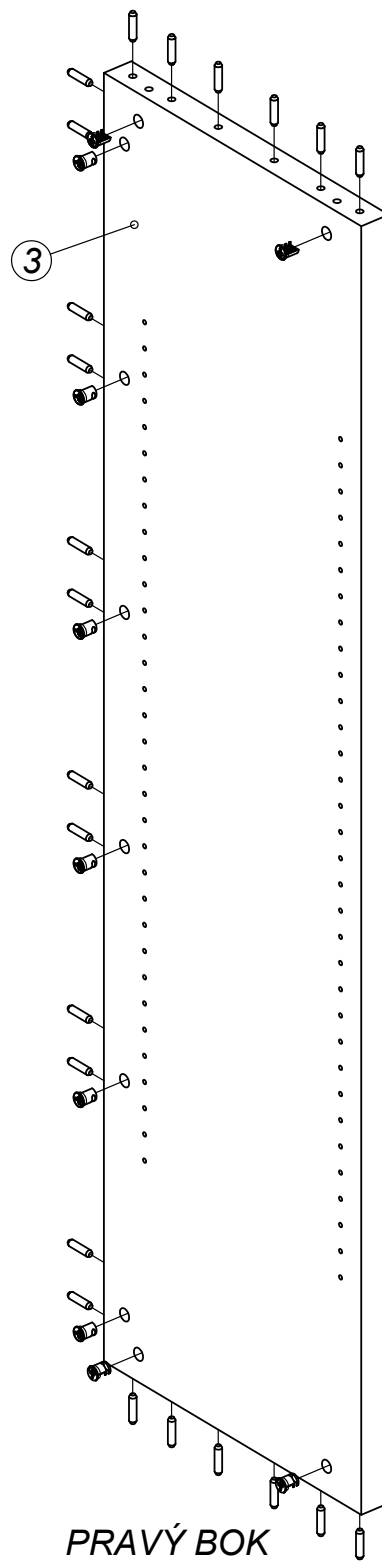
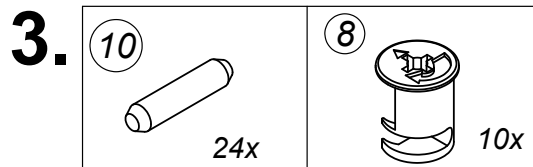
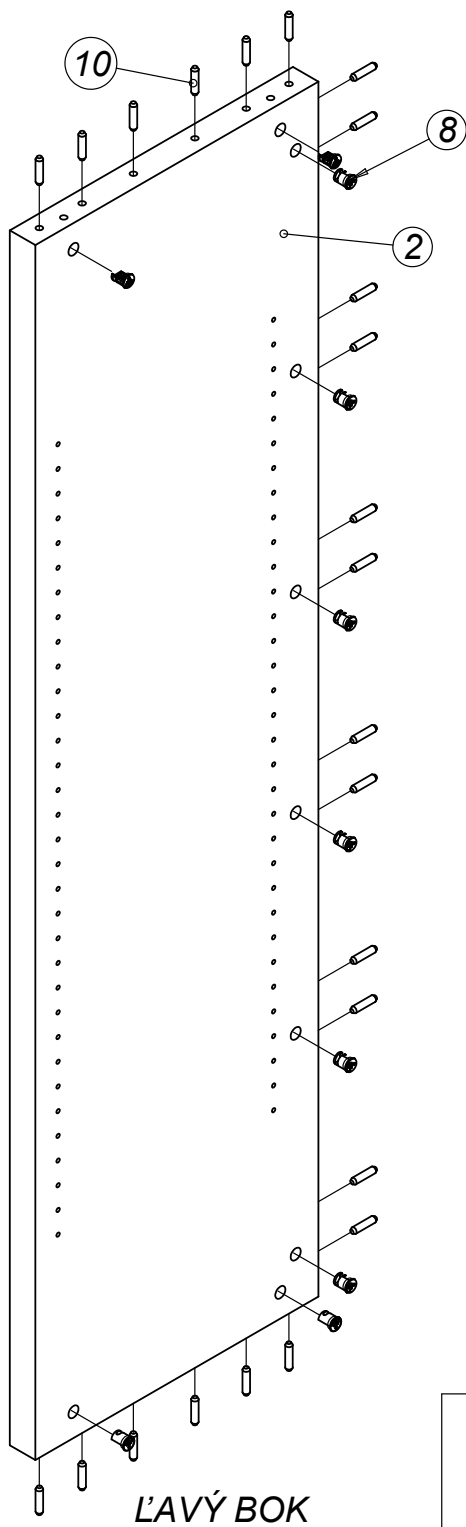
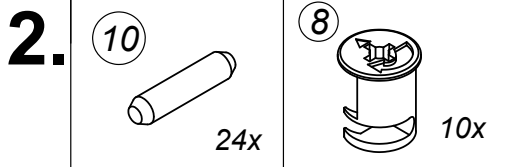

4.

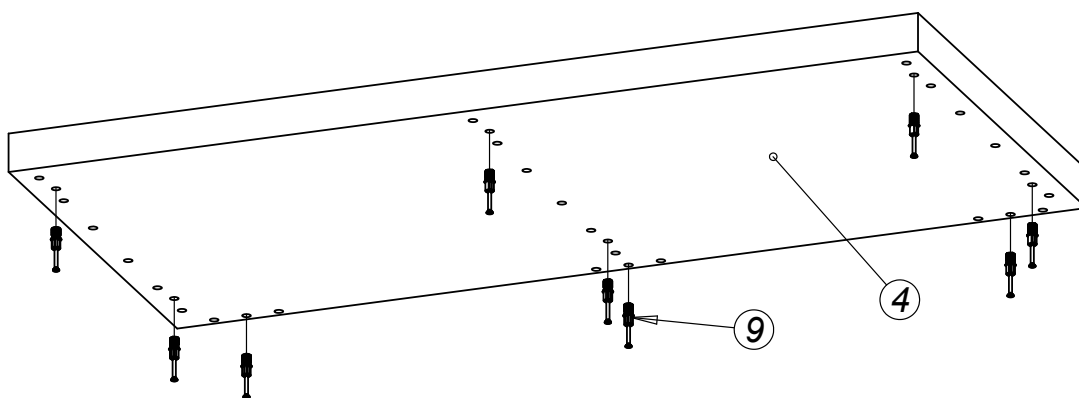
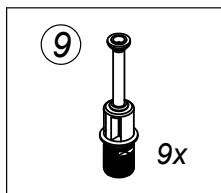

5.

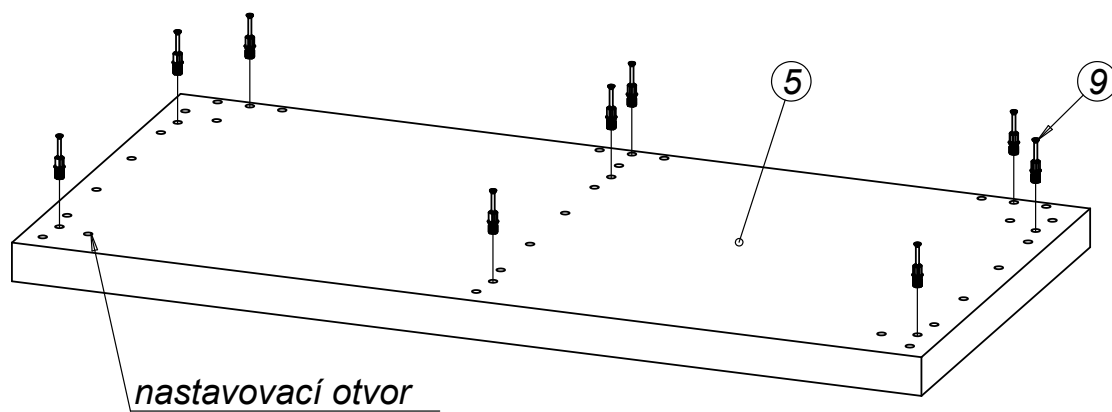
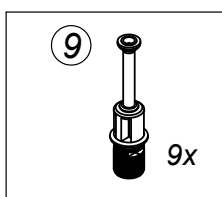

6.

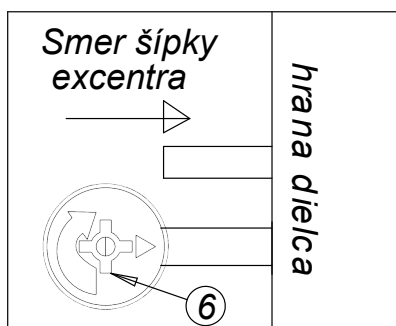
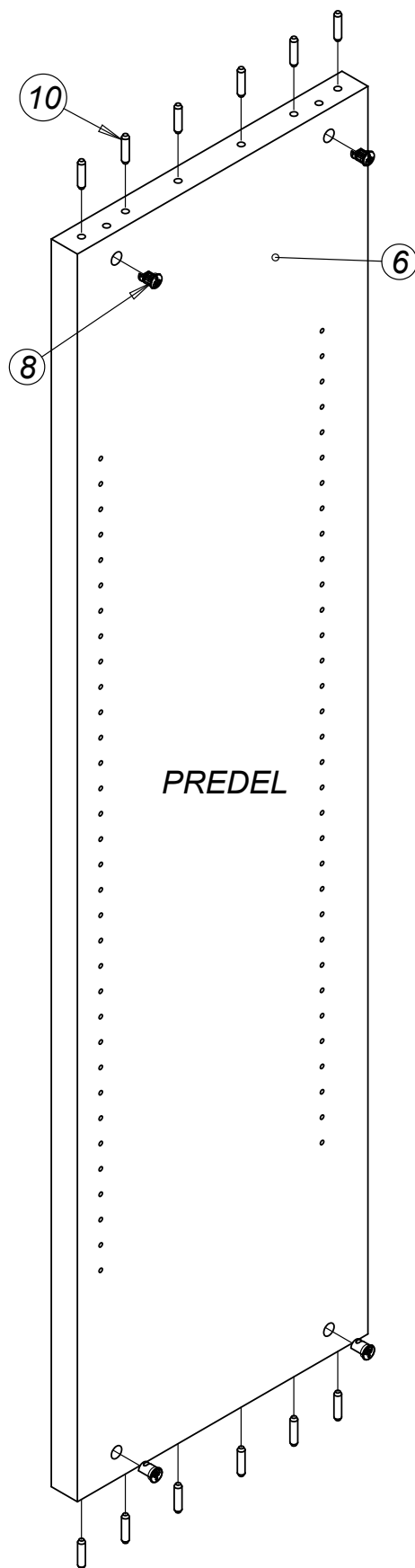
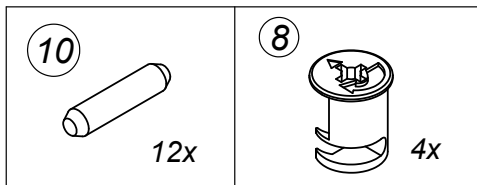

7.

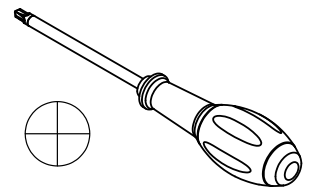
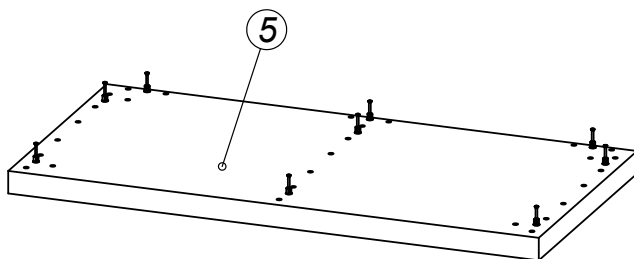
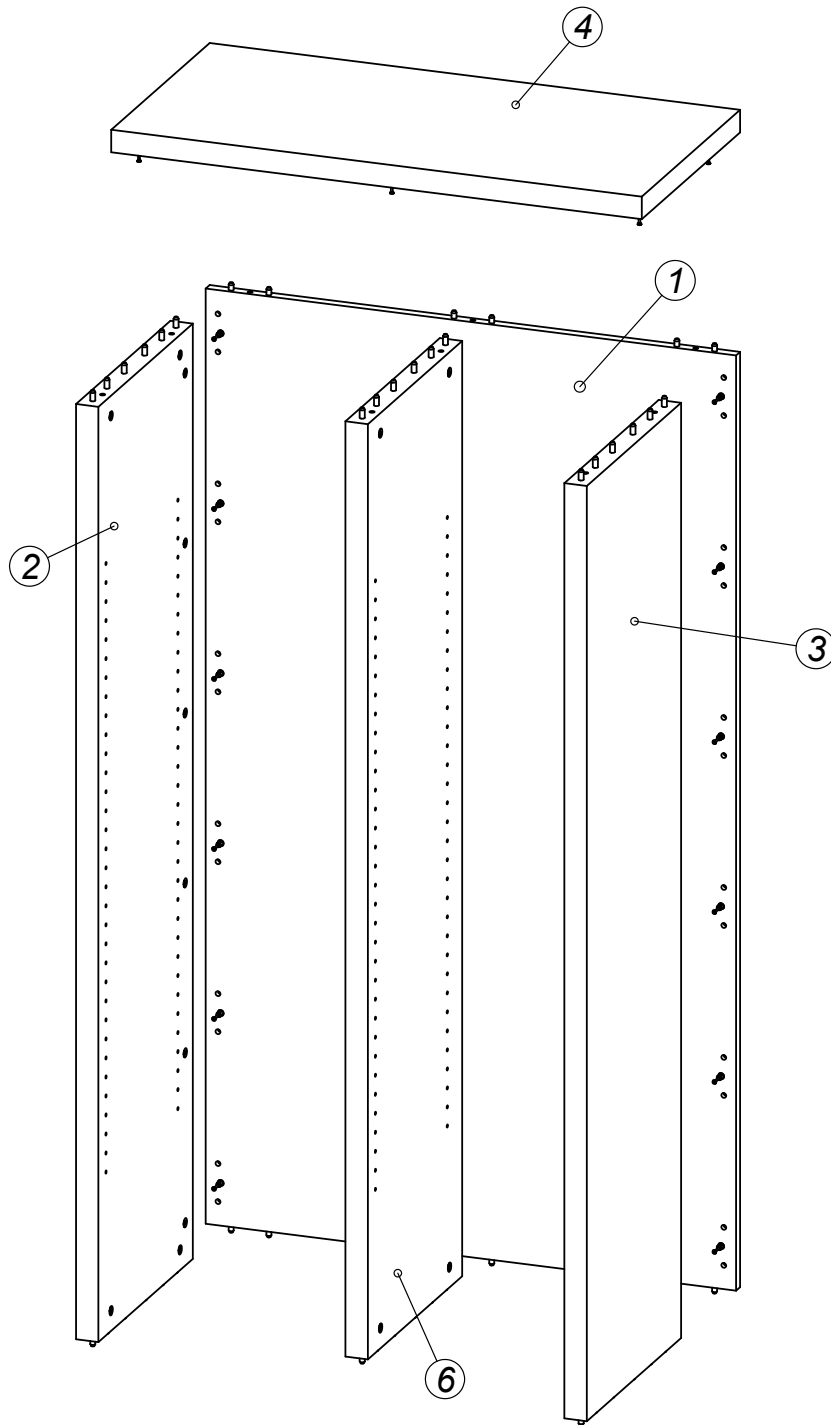

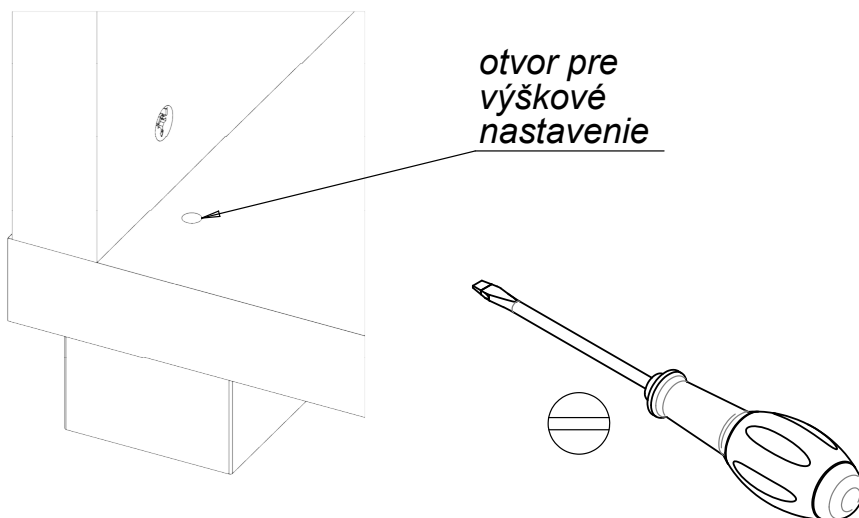
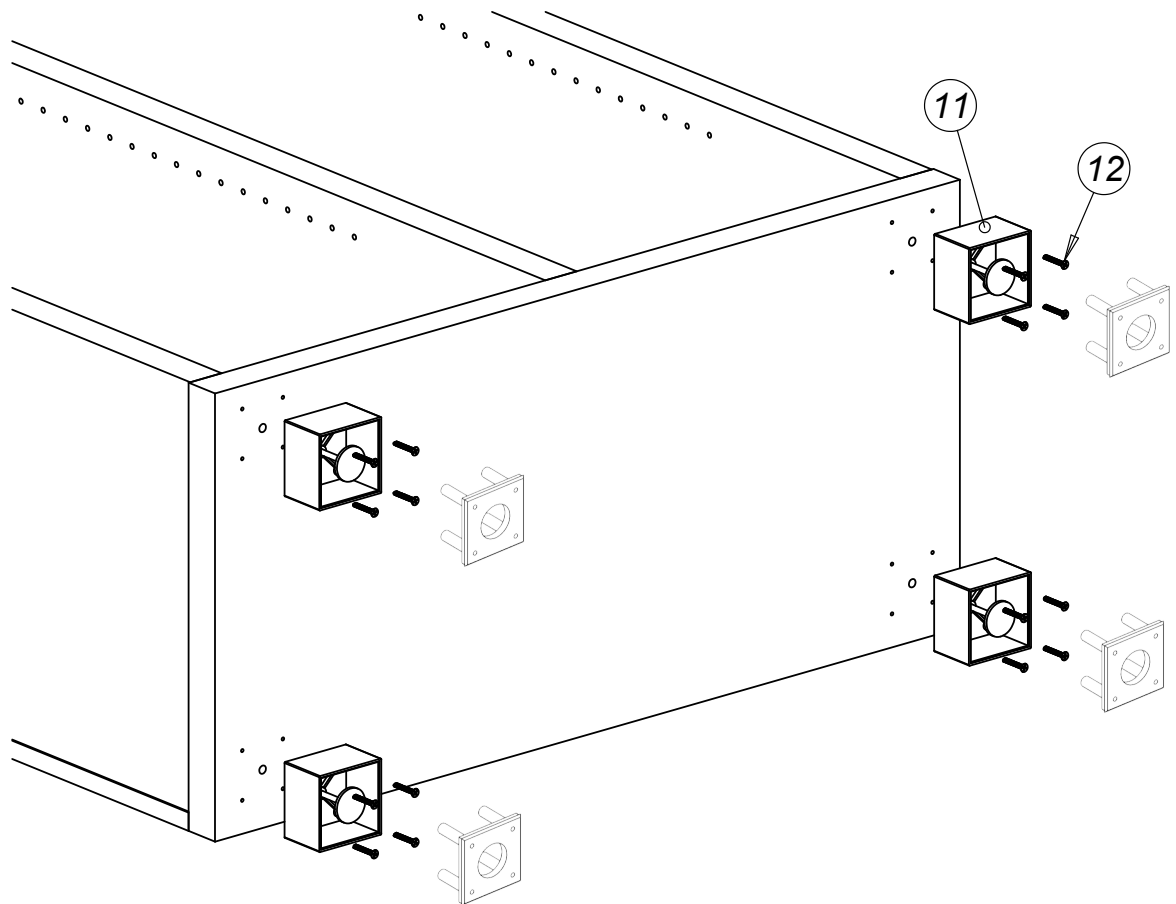
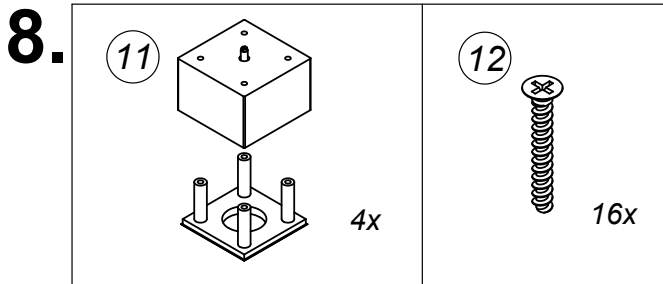

ĎAKUJEME ZA ZAKÚPENIE NÁŠHO VÝROBKU!